

PRODUCT DESCRIPTION

Recessed downlighter with very small trim for general or accent lighting.
Aluminium luminaire available in different colors. Standard equipped with torsion springs.



TECHNICAL DATA

Application	ceiling - recessed
Dimensions	cut out: ø92mm h140mm
IP rating	IP55
Power	500mA
Lifetime L70/F10/65°C	>55000h
MacAdam ellipse	3
Guarantee	5 year

(*on components, only if ordered luminaire + driver)

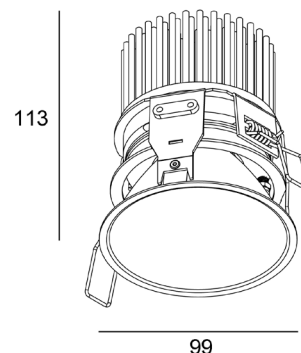

Color Temperature	Wattage	Forward Current	Lumen (LED) (at tp = 65°C)	Lumen/Watt (LED) (at tp = 65°C)	CRI	Energy Label
2400K	16,9W	500mA	1181 lm	70 lm/W	90+	F
2700K	16,9W	500mA	2232 lm	139 lm/W	90+	E
3000K	16,9W	500mA	2458 lm	148 lm/W	90+	E
4000K <u>only for White/Black</u>	16,9W	500mA	2569 lm	156 lm/W	90+	E

ORDER REFERENCE

> LUMINAIRE

! ORDER REFERENCE + W (white) / B (black) / A (alu) C (champagne) / BR (bronze) / T (titanium)

2400K	ZUMI351960107	UKKIE M SLE G7 21mm 1181lm 500mA 16,9W 2400K CRI90 excl.driver
2700K	ZUMI351960107	UKKIE M SLE G7 21mm 2232lm 500mA 16,9W 2700K CRI90 excl.driver
3000K	ZUMI351970107	UKKIE M SLE G7 21mm 2458lm 500mA 16,9W 3000K CRI90 excl.driver
4000K	ZUMI351990107	UKKIE M SLE G7 21mm 2569lm 500mA 16,9W 4000K CRI90 excl.driver

> DRIVER

dimmable

TRID28000671+28001114 LCA 25W 350–1050mA one4all SR PRE + plug 500mA

non dimmable

TRID28000700 +28001114 LC 25W 350–1050mA flexC SR EXC + plug 500mA

> OPTIONS

Flat Springs

ZUMIFS Flat Springs

Emergency kit

On request

PRODUCT DESCRIPTION

Recessed downlighter with very small trim for general or accent lighting.

The PI-LED-version makes it possible to change color from 1800K to 16000K but also to create all additional RGB-colors. This way any atmosphere can be created. Available in two different versions: the low output (375mA) or the high output (500mA) version.

Aluminium luminaire available in different colors. Standard equipped with torsion springs.



TECHNICAL DATA

Application ceiling - recessed
 Dimensions cut out: ø92mm h140mm
 IP rating IP55
 Power 48V
 Lifetime L70/F10/65°C 50000h
 MacAdam ellipse 3
 Guarantee 5 year

(*on components, only if ordered luminaire + driver)

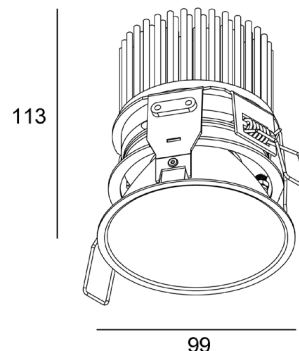

Color Temperature	Wattage	Forward Current	Lumen (LED) (at tp = 65°C)	Lumen/Watt (LED) (at tp = 65°C)	CRI	Energy Label
1800K-16000K RGB	22W	375mA	2300 lm	105 lm/W	90+	F
1800K-16000K RGB	31W	500mA	3000 lm	97 lm/W	90+	F

ORDER REFERENCE

> LUMINAIRE

! ORDER REFERENCE + W (white) / B (black) / A (alu) C (champagne) / BR (bronze) / T (titanium)

LO
 ZUMI351310104 UKKIE M PI-LED LO 22W 2300lm CRI90+ excl.driver

HO
 ZUMI351330104 UKKIE M PI-LED HO 31W 3000lm CRI90+ excl.driver

> DRIVER - REQUIRED!

375/500mA - 48V
 LUMILTP1067 LED Driver for PI-LED Systems 60W/48V

> OPTION

Flat Springs
 ZUMIFS Flat Springs

PRODUCT DESCRIPTION

Recessed downlighter with very small trim for general or accent lighting.
The tunable white version has a color temperature range from 2700K up to 6500K.

Aluminium luminaire available in different colors. Standard equipped with torsion springs.

**TECHNICAL DATA**

Application	ceiling - recessed
Dimensions	cut out: \varnothing 92mm h140mm
IP rating	IP55
Power	850mA
Lifetime L70/B10/65°C	60000h
MacAdam ellipse	3
Guarantee	5 year

(*on components, only if ordered luminaire + driver)

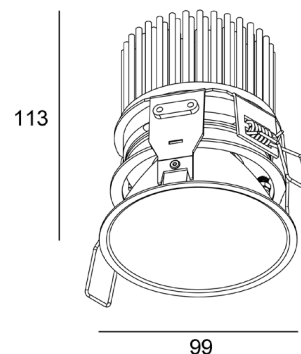

Color Temperature	Wattage	Forward Current	Lumen (LED) (at tp = 65°C)	Lumen/Watt (LED) (at tp = 65°C)	CRI	Energy Label
WW	27,6W	850mA	2812 lm	102 lm/W	90	F
CW	27,6W	850mA	2776 lm	101lm/W	90	F

ORDER REFERENCE

> LUMINAIRE

! ORDER REFERENCE + W (white) / B (black) / A (alu) C (champagne) / BR (bronze) / T (titanium)

ZUMI352780325 Ukkie M TW SLE3000 PRE2 2812/2776lm 27,6W 2700-6500K CRI90+ excl. driver

> DRIVER - REQUIRED!

dimnable DALI DT8 (only Device Type 8), switchDIM

TRID28002202	LCA 38W 350-1050mA DT8 SR PRE
TRID28001121	I-SELECT 2 PLUG 850MA BL (DALI DT8 (only Device Type 8), switchDIM) +colourswitch by push button

Control via switchDIM:

A driverentional double pushbutton switch can be used for control via switchDIM.
One of the pushbuttons is used to set the colour temperature, the other to set the dimming level.

For control via a switchDIM switch different settings can be made:

- Setting for the colour temperature via colourTEMPERATURE mode or colourSWITCH mode with 8 predefined values 2,700 K and 6,500 K.
- Stepless setting for the dimming level between 15 and 100 %.

> OPTIONS

PC-cover

ZUMI010000000500 PC-cover for food environment \varnothing 111

Flat Springs

ZUMIFS Flat Springs

PRODUCT DESCRIPTION

Recessed downlighter with very small trim for general or accent lighting.
Aluminium luminaire available in different colors. Standard equipped with torsion springs.



TECHNICAL DATA

Application ceiling - recessed
 Dimensions cut out: ø140mm h160mm
 IP rating IP55
 Power 700mA
 Lifetime L70/F10/65°C >55000h
 MacAdam ellipse 3
 Guarantee 5 year
 (*on components, only if ordered luminaire + driver)

Color Temperature	Wattage	Forward Current	Lumen (LED) (at tp = 65°C)	Lumen/Watt (LED) (at tp = 65°C)	CRI	Energy Label
2400K	23,6W	700mA	1653 lm	71 lm/W	90+	F
2700K	23,6W	700mA	3125 lm	134 lm/W	90+	E
3000K	23,6W	700mA	3441 lm	147 lm/W	90+	E
4000K <u>only Black/White</u>	23,6W	700mA	3596 lm	154 lm/W	90+	E

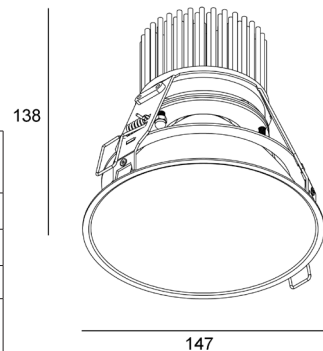

ORDER REFERENCE

> LUMINAIRE

! ORDER REFERENCE + W (white) / B (black) / A (alu) C (champagne) / BR (bronze) / T (titanium)

2400K	ZUMI361910108	UKKIE L SLE G7 1653lm 700mA 23,6W 2400K CRI90 excl.driver
2700K	ZUMI361960108	UKKIE L SLE G7 3125lm 700mA 23,6W 2700K CRI90 excl.driver
3000K	ZUMI361970108	UKKIE L SLE G7 3441lm 700mA 23,6W 3000K CRI90 excl.driver
4000K	ZUMI361990108	UKKIE L SLE G7 3596lm 700mA 23,6W 4000K CRI90 excl.driver

> DRIVER

dimmable

TRID28000671 + 28001118 LC 25W 350-1050mA one4all SR PRE + plug 700mA

non dimmable

TRID28000700 + 28001118 LC 25W 350-1050mA flexC SR EXC + plug 700mA

> OPTION

Flat Springs

ZUMIFS Flat Springs

Emergency kit

On request

PRODUCT DESCRIPTION

Recessed downlighter with very small trim for general or accent lighting.

The PI-LED-version makes it possible to change color from 1800K to 16000K but also to create all additional RGB-colors. This way any atmosphere can be created. Available in two different versions: the low output (375mA) or the high output (500mA) version.

Aluminium luminaire available in different colors. Standard equipped with torsion springs.



TECHNICAL DATA

Application ceiling - recessed
 Dimensions cut out: ø140mm h160mm
 IP rating IP55
 Power 48V
 Lifetime L70/F10/65°C 50000h
 MacAdam ellipse 3
 Guarantee 5 year
 (*on components, only if ordered luminaire + driver)

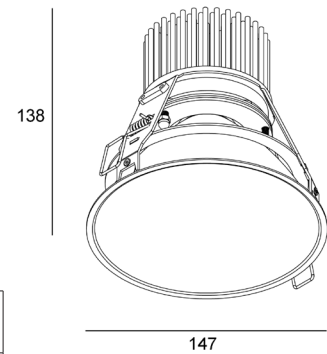

Color Temperature	Wattage	Forward Current	Lumen (LED) (at tp = 65°C)	Lumen/Watt (LED) (at tp = 65°C)	CRI	Energy Label
WHITE REFLECTOR						
1800K-16000K RGB	22W	375mA	2300 lm	105 lm/W	90+	F
1800K-16000K RGB	31W	500mA	3000 lm	97 lm/W	90+	F

ORDER REFERENCE

> LUMINAIRE

! ORDER REFERENCE + W (white) / B (black) / A (alu) C (champagne) / BR (bronze) / T (titanium)

LO

DALI ZUMI361310106 UKKIE L PI-LED LO 375mA 22W 2300lm CRI90+ excl.driver

HO

DALI ZUMI361330107 UKKIE L PI-LED HO 500mA 31W 3000lm CRI90+ excl.driver

> DRIVER - REQUIRED!

375/500mA - 48V
 LUMILTP1067 LED Driver for PI-LED Systems 60W/48V

> OPTION

Flat Springs
 ZUMIFS Flat Springs

PRODUCT DESCRIPTION

Recessed downlighter with very small trim for general or accent lighting.
The tunable white version has a color temperature range from 2700K up to 6500K.

Aluminium luminaire available in different colors. Standard equipped with torsion springs.



TECHNICAL DATA

Application ceiling - recessed
 Dimensions cut out: ø140mm h160mm
 IP rating IP55
 Power 850mA
 Lifetime L70/B10/65°C 60000h
 MacAdam ellipse 3
 Guarantee 5 year
 (*on components, only if ordered luminaire + driver)

Color Temperature	Wattage	Forward Current	Lumen (LED) (at tp = 65°C)	Lumen/Watt (LED) (at tp = 65°C)	CRI	Energy Label
WW	27,6W	850mA	2812 lm	102 lm/W	90	F
CW	27,6W	850mA	2776 lm	101lm/W	90	F

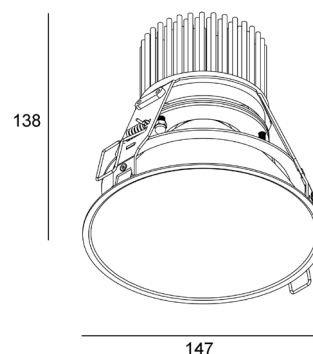

ORDER REFERENCE

> LUMINAIRE

! ORDER REFERENCE + W (white) / B (black) / A (alu) C (champagne) / BR (bronze) / T (titanium)

ZUMI362780325 Ukkie L TW SLE3000 PRE2 2812/2776lm 27,6W 2700-6500K CRI90+ excl. driver

> DRIVER - REQUIRED!

dimnable DALI DT8 (only Device Type 8), switchDIM

TRID28002202 LCA 38W 350-1050mA DT8 SR PRE
 TRID28001121 I-SELECT 2 PLUG 850MA BL
 (DALI DT8 (only Device Type 8), switchDIM) +colourswitch by push button

Control via switchDIM:

A driverentional double pushbutton switch can be used for control via switchDIM.
One of the pushbuttons is used to set the colour temperature, the other to set the dimming level.

For control via a switchDIM switch different settings can be made:

- Setting for the colour temperature via colourTEMPERATURE mode or colourSWITCH mode with 8 predefined values 2,700 K and 6,500 K.
- Stepless setting for the dimming level between 15 and 100 %.

> OPTIONS

PC-cover

ZUMI010000000500 PC-cover for food environment ø 111

Flat Springs

ZUMIFS Flat Springs